

Solar System Mobile

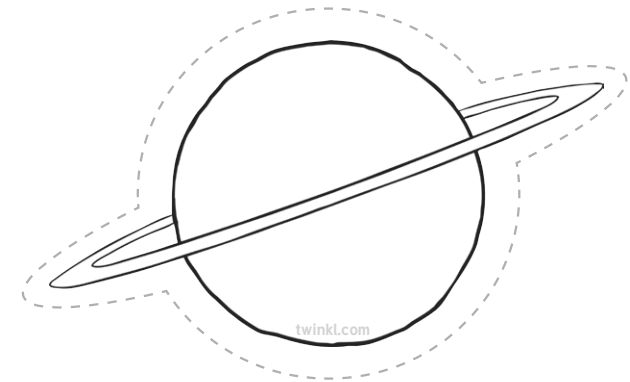
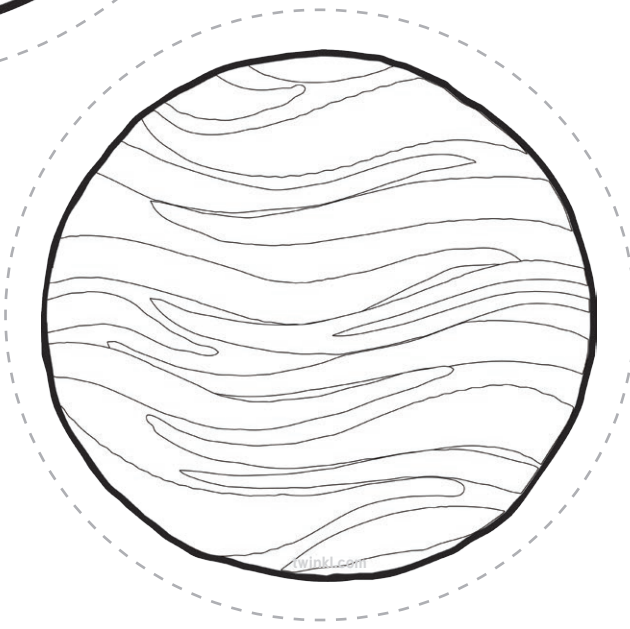
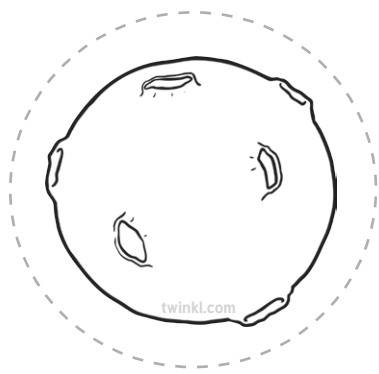
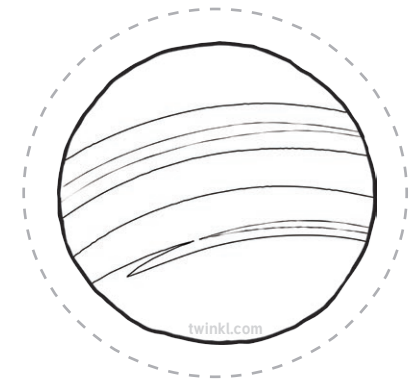
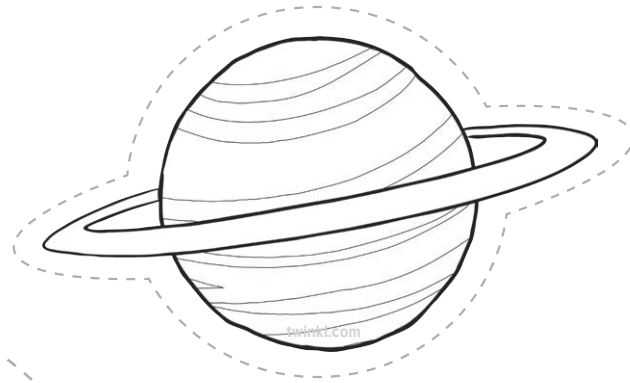
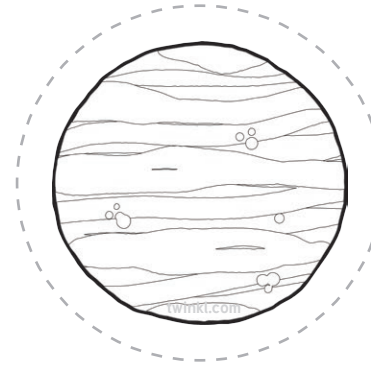
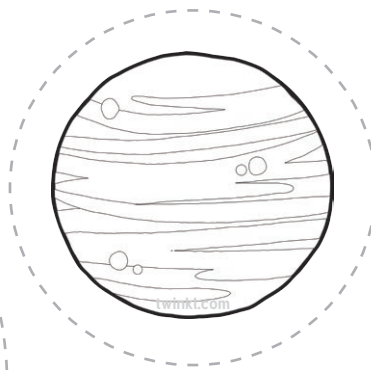

Solar System Mobile

You will need:

Solar System Printable
Page

Crayons

Scissors

Glue

Wool or string

Hole puncher

Wooden dowel rod

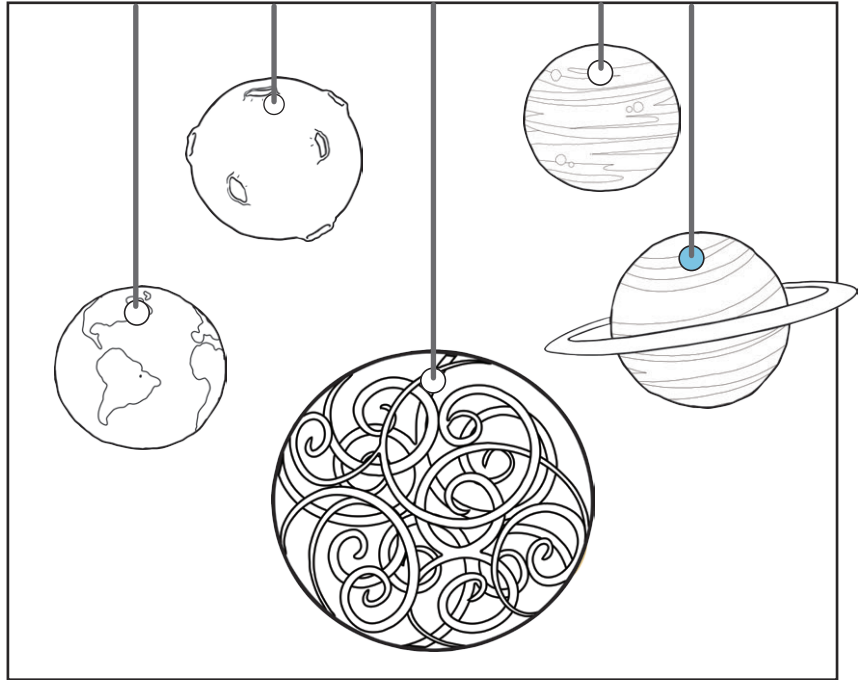

Instructions

1. Colour and cut out the planets on the solar system printable page.
2. Use the hole puncher to make a hole at the top of each planet.
3. Attach wool or string to each of the planets.
4. Tie the planets to the dowel rod.
5. Make a hanger using the wool or string and hang your solar system mobile!

